

6817

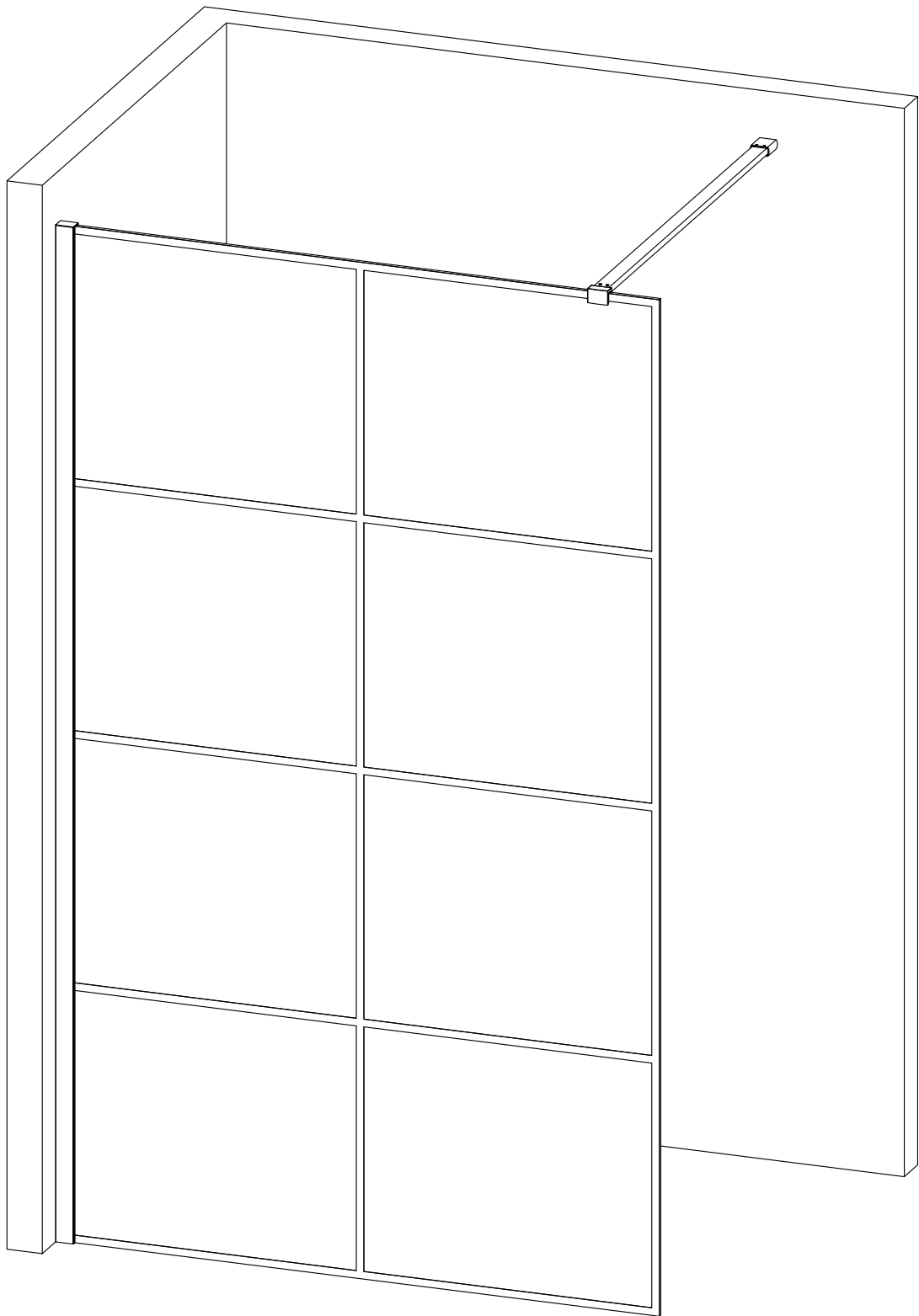

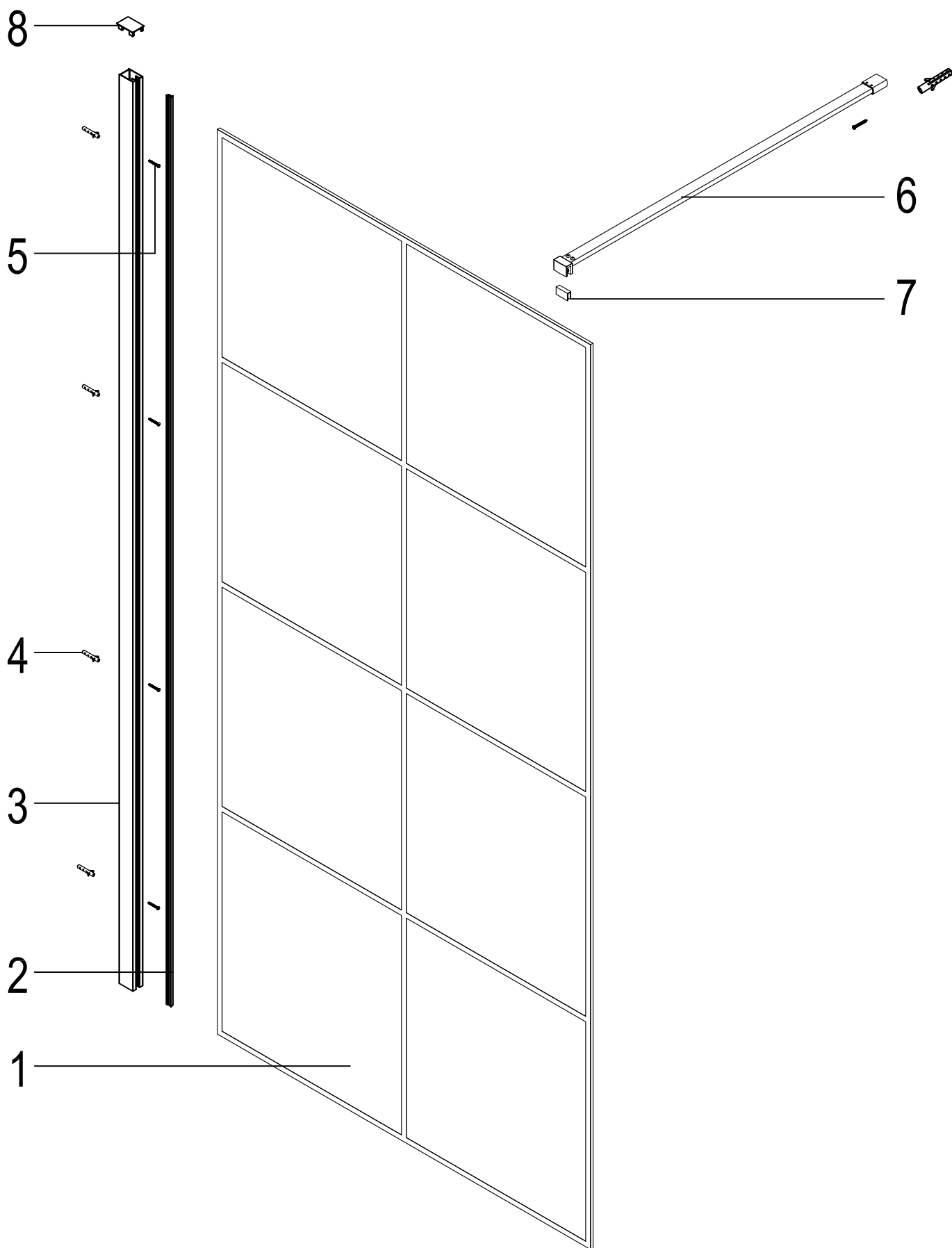

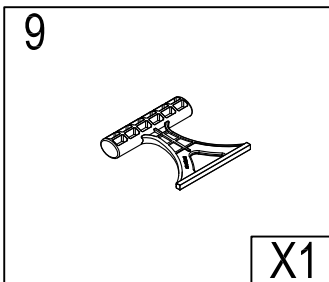

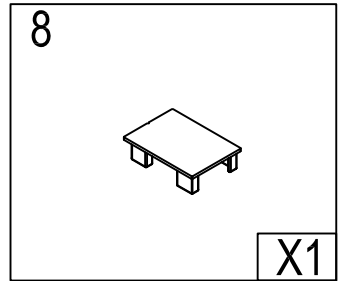
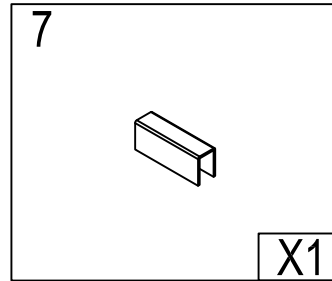
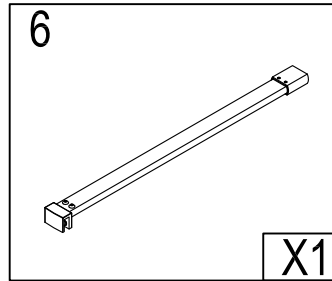
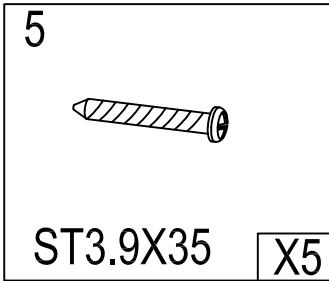
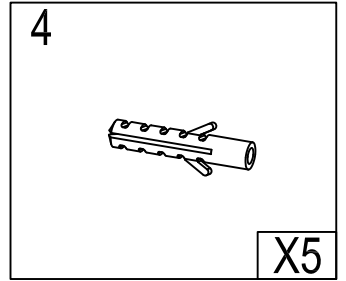
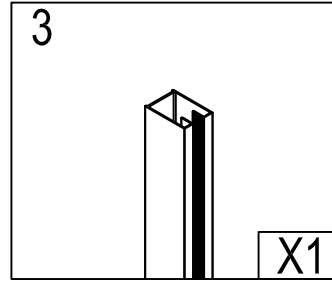
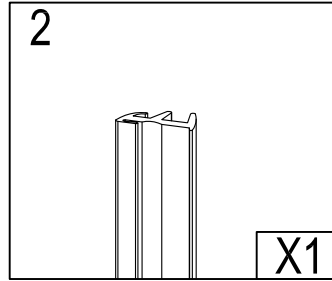
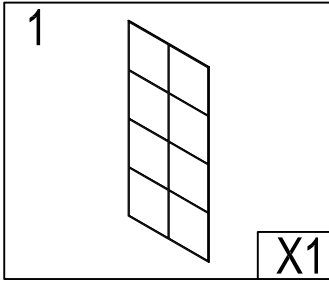
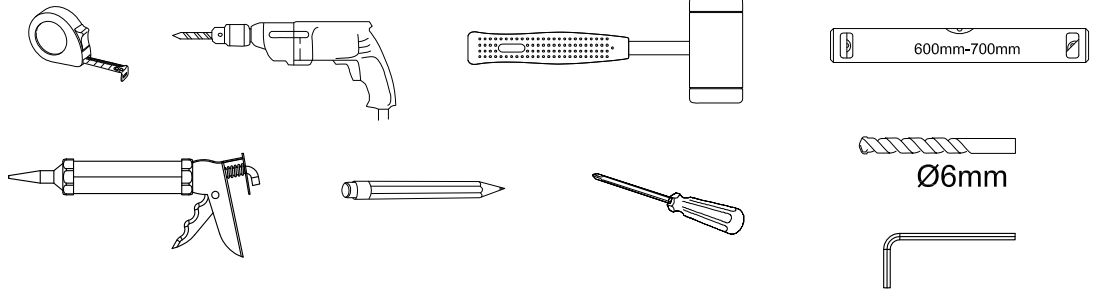
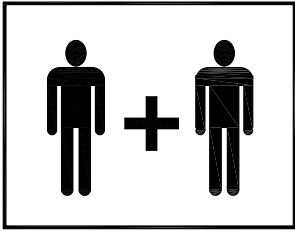
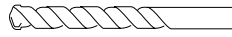
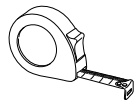
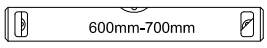

Ø6mm

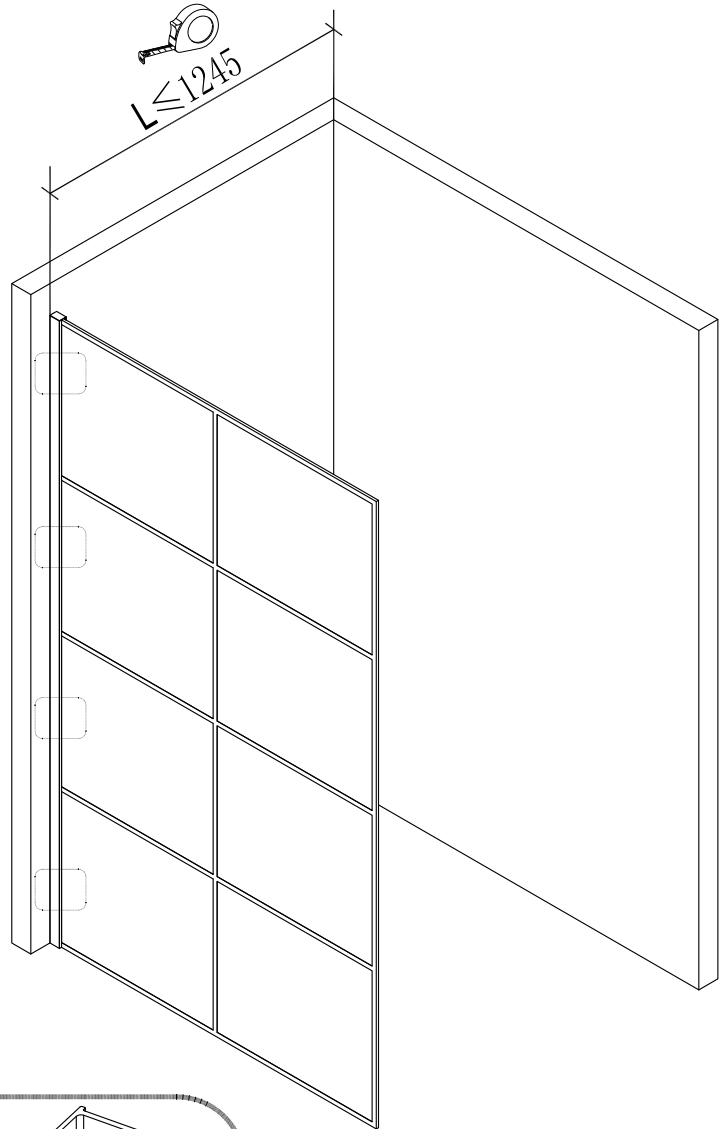
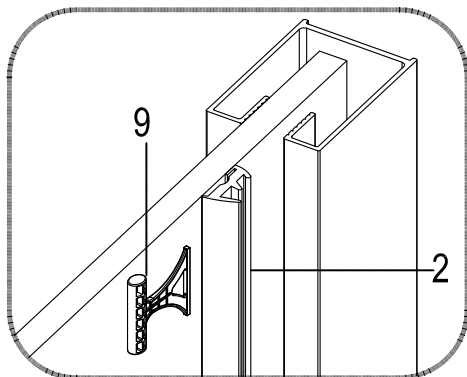
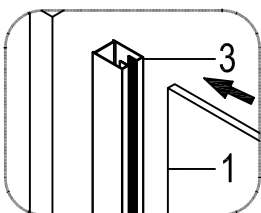
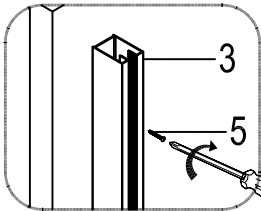
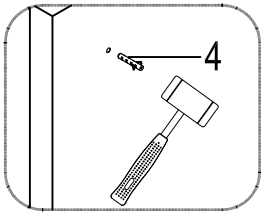
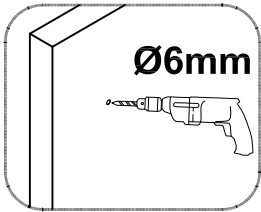
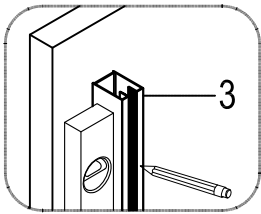
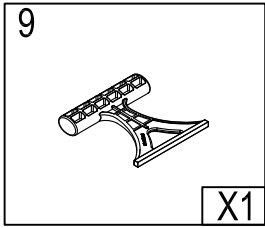
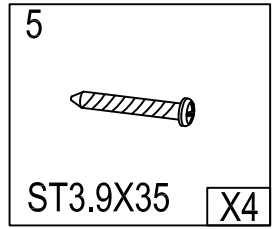
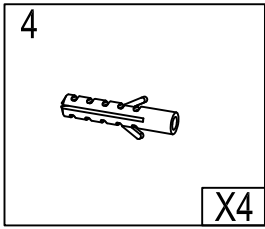
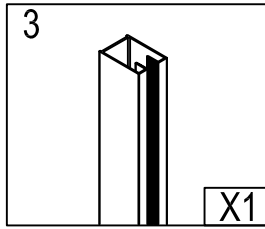
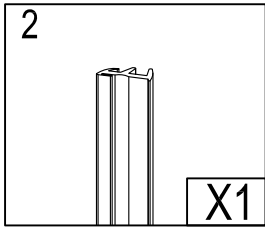
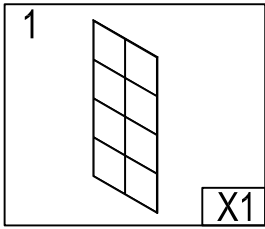
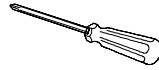
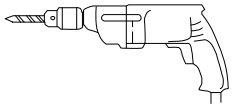
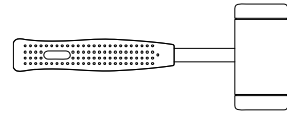

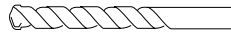
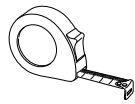
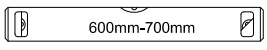

Ø6mm

